

Test report

REPORT NO.:
214942-3-EN



**DANISH
TECHNOLOGICAL
INSTITUTE**

Teknologiparken
Kongsvang Allé 29
DK-8000 Aarhus C
+45 72 20 20 00
Info@teknologisk.dk
www.teknologisk.dk

Page 1 of 7
Init.: mmh/mjld
Report no.: 214942-3-EN
Appendices: 1

Assignor:	Dolle A/S Vestergade 47 DK-7741 Frøstrup
Item:	Loft ladder, model SW64-4, outer frame measuring 1175 x 676 mm.
Sampling:	The test material was forwarded by the client and received at the Danish Technological Institute, Aarhus on 2023-09-20. The test material was labelled "214942-3" by the laboratory.
Period:	Testing took place on 2023-09-20.
Method:	EN 1026:2016 – Windows and doors – Air permeability – Test method
Result:	Class 4 at ± 600 Pa according to EN 12207:2016 – Windows and doors – Air permeability – Classification
Terms:	This analysis/test was conducted accredited in accordance with international requirements (ISO/IEC 17025:2017) and in accordance with the General Terms and Conditions of Danish Technological Institute. The test results solely apply to the tested item. This analysis report/test report may be quoted in extract only if Danish Technological Institute has granted its written consent.
Place:	2023-09-29, Danish Technological Institute, Building and Construction, Aarhus.

Performed by:

Mads Borregaard Hansen
Consultant, Engineering

Co-reader:

Morten Jul Laegaard
Business Manger



DIGITALLY SIGNED DOCUMENT

DANISH TECHNOLOGICAL INSTITUTE





Test procedure

The test specimen is a loft ladder made of wood with an insulated trapdoor and a 3-section ladder mounted with a spring system and with a sealing of the type Q-lon.

The client has provided the following information about the construction of the test specimen:

Product name	SW64-4 : 1175 x 676 : H/H : 190F : ST2 : 3D/4G//4B/12T : SA
Length x width	1175 x 676 mm
Gaskets	White Q-LON. see appendix 1
Trapdoor	Outer measure 1149 x 632 mm – insulated with EPS

The loft ladder is mounted in a plate to facilitate the mounting in the test rig, without in any way hinder its normal function. The mounting in the test rig is vertical.

The test conditions and the dimensions of the test specimen are measured by the laboratory and are:

Width [mm]	Height [mm]	Area [m ²]	Length of joint [m]	Temperature [°C]	Relative humidity [%]	Atmospheric pressure [hPa]
676	1175	0.794	3.56	22.28	64.8	1003.9



Photo 1: Specimen before testing



Photo 2: Specimen after testing



Test results

Air permeability – Positive air pressure

Air pressure	Air flow Total	Air flow Area	Air flow Length of joint	Class Area	Class Length of joint
[Pa]	[m ³ /h]	[m ³ /h/m ²]	[m ³ /h/m]	[-]	[-]
50	0.10	0.12	0.03	4	4
100	0.10	0.12	0.03	4	4
150	0.10	0.12	0.03	4	4
200	0.10	0.12	0.03	4	4
250	0.10	0.12	0.03	4	4
300	0.10	0.12	0.03	4	4
450	0.10	0.12	0.03	4	4
600	0.81	1.02	0.23	4	4

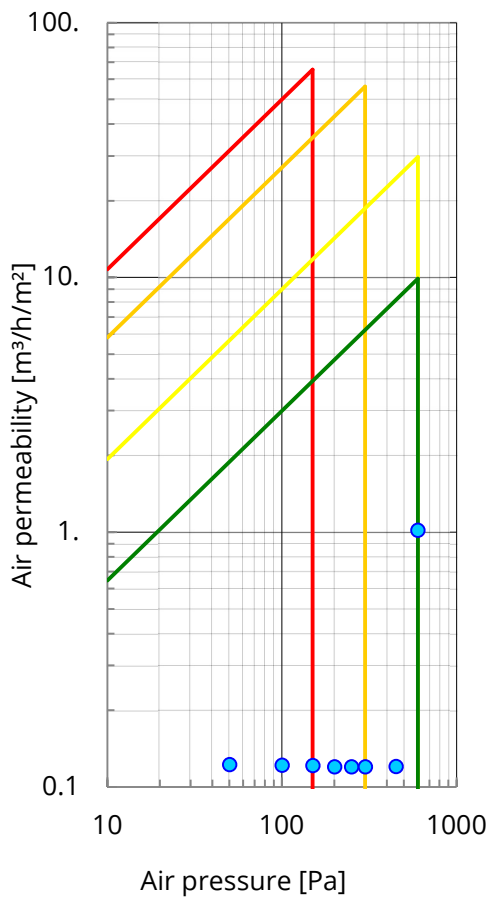

Air permeability related to area.

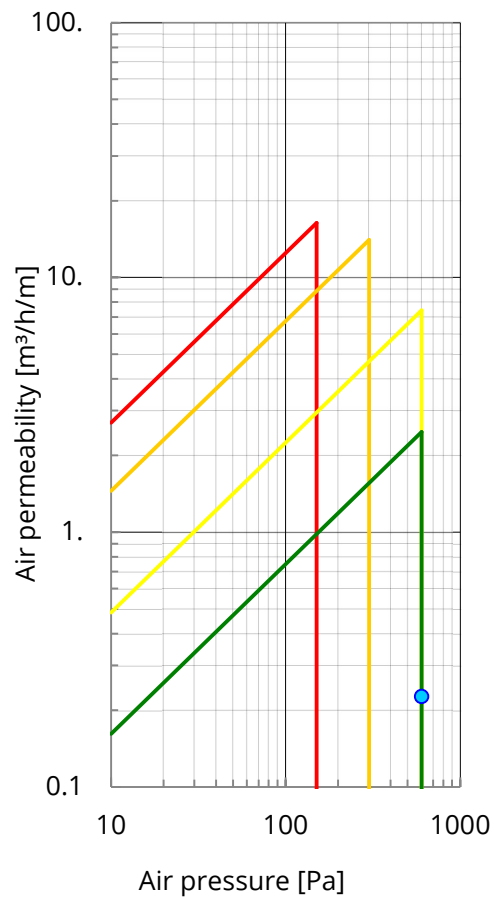

Air permeability related to length of joint.

The graphs show the classification in relation to the area and the length of joint. Classes 1-4 are indicated by red, orange, yellow and green fields respectively.



Test results – Air permeability – Negative air pressure

Air pressure	Air flow Total	Air flow Area	Air flow Length of joint	Class Area	Class Length of joint
[Pa]	[m ³ /h]	[m ³ /h/m ²]	[m ³ /h/m]	[-]	[-]
50	0.10	0.12	0.03	4	4
100	0.10	0.12	0.03	4	4
150	0.10	0.12	0.03	4	4
200	0.10	0.12	0.03	4	4
250	0.10	0.12	0.03	4	4
300	0.10	0.12	0.03	4	4
450	0.10	0.12	0.03	4	4
600	0.20	0.24	0.06	4	4

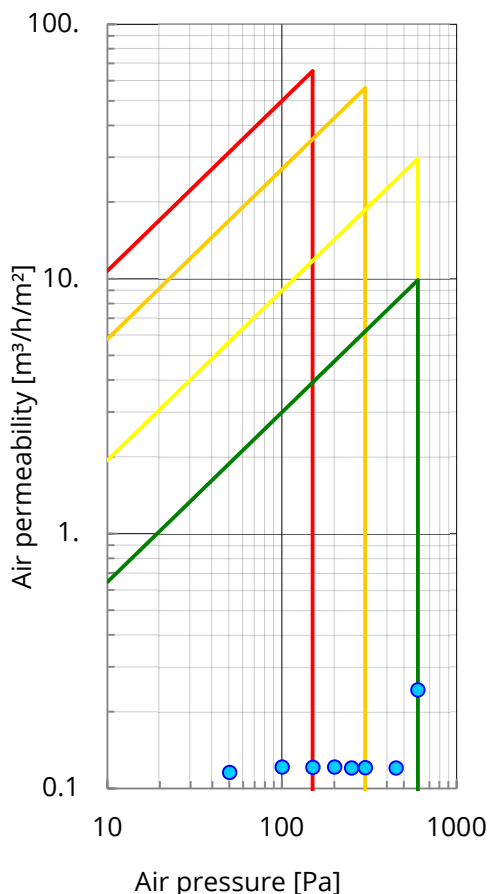

Air permeability related to area.

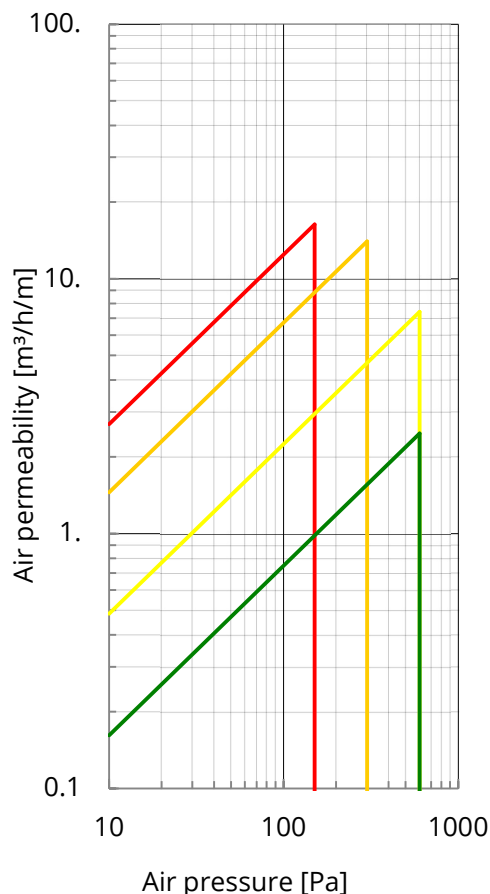

Air permeability related to length of joint.

The graphs show the classification in relation to the area and the length of joint. Classes 1-4 are indicated by red. orange. yellow and green fields respectively.



Test results e- Average air permeability

Air pressure	Air flow Total	Air flow Area	Air flow Length of joint	Class Area	Class Length of joint
[Pa]	[m ³ /h]	[m ³ /h/m ²]	[m ³ /h/m]	[-]	[-]
50	0.10	0.12	0.03	4	4
100	0.10	0.12	0.03	4	4
150	0.10	0.12	0.03	4	4
200	0.10	0.12	0.03	4	4
250	0.10	0.12	0.03	4	4
300	0.10	0.12	0.03	4	4
450	0.10	0.12	0.03	4	4
600	0.50	0.63	0.14	4	4

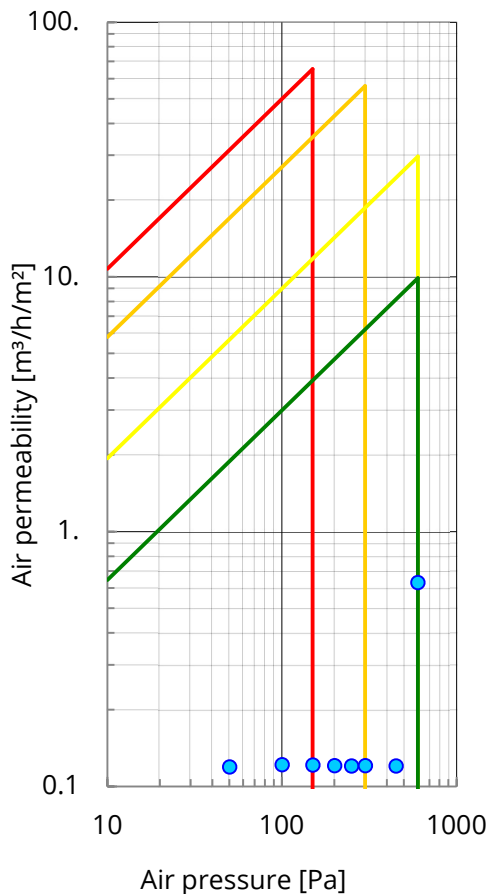

Air permeability related to area.

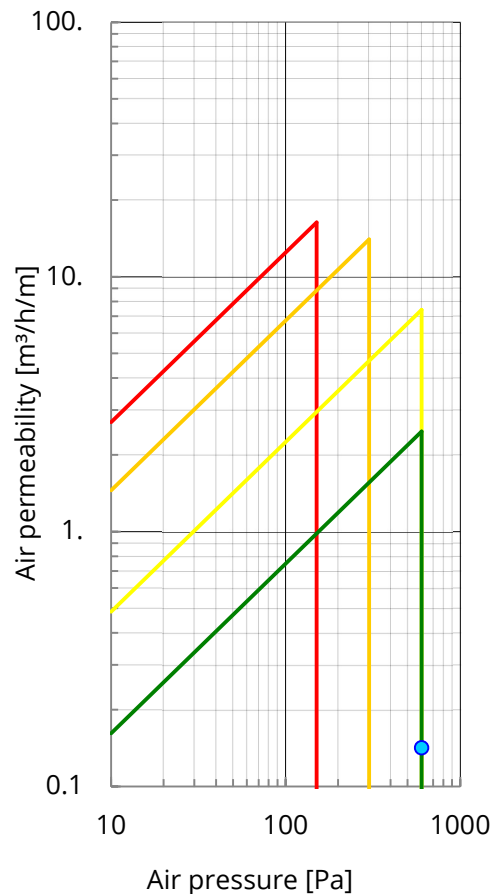

Air permeability related to length of joint.

The graphs show the classification in relation to the area and the length of joint. Classes 1-4 are indicated by red. orange. yellow and green fields respectively.



Description of specimen

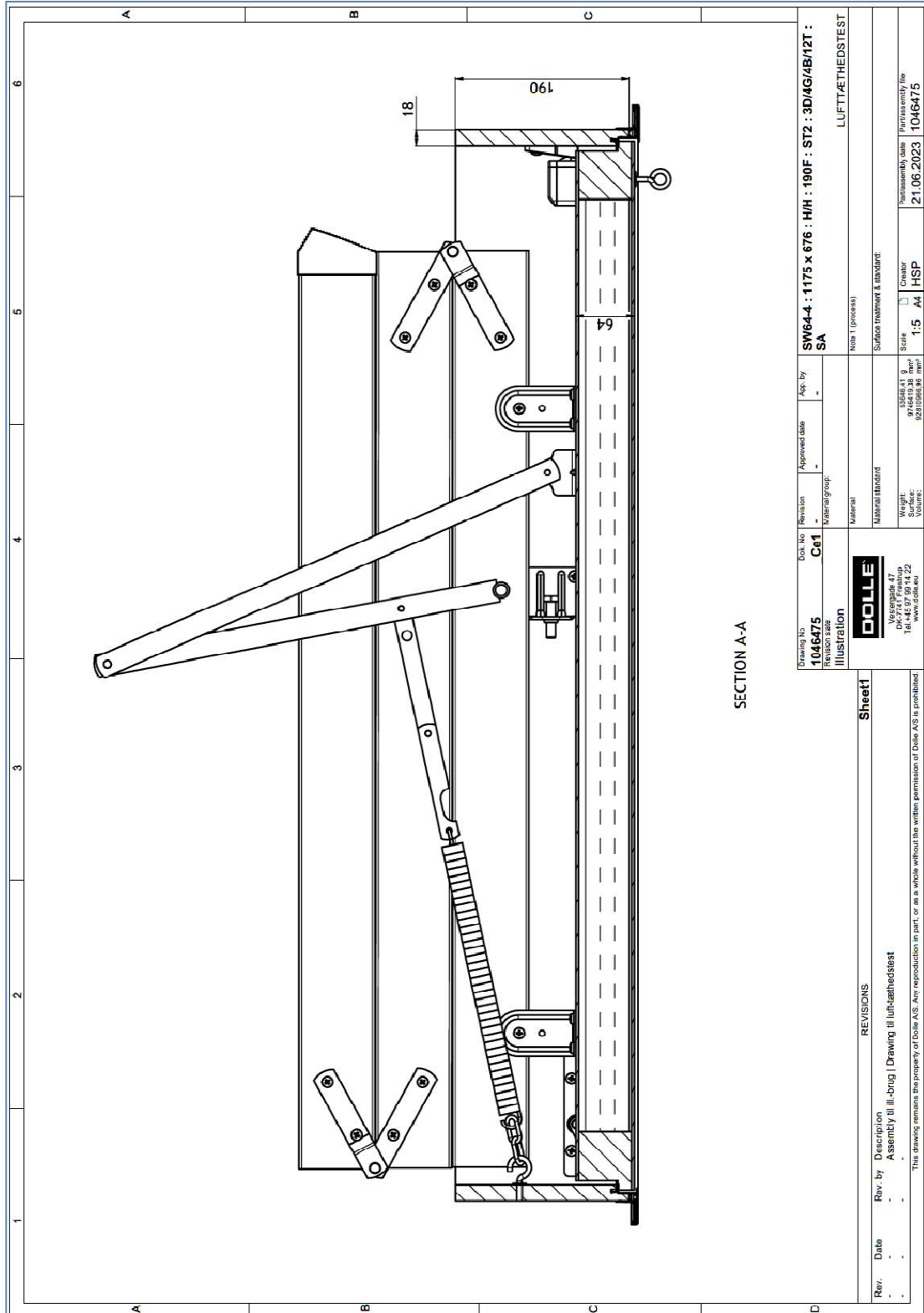

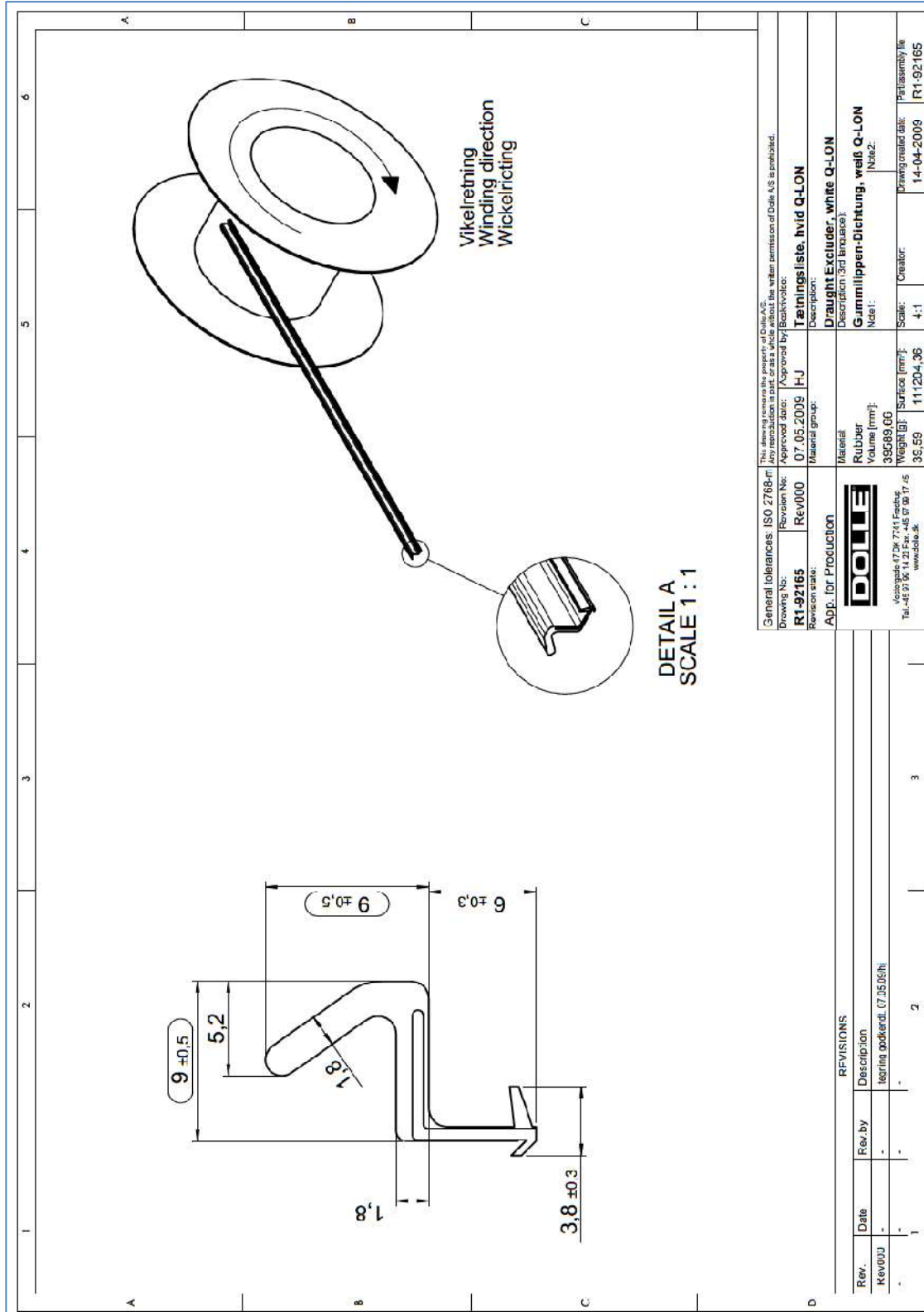

General tolerances: ISO 2768-M		This drawing remains the property of Dole A/S. Any reproduction in part or as a whole without the written permission of Dole A/S is prohibited.	
Drawing No:	R1-92165	Approved date:	07.05.2009
Revision No:	Rev000	Approved by:	H-J
Revision state:	App. for Production	Material group:	Tætningsliste, hvid Q-LON
REVISIONS		Description:	Draught Excluder, white Q-LON
Rev.	Date	Rev. by	Description
Rev000	-	-	Gummilippen-Dichtung, weiß Q-LON
-	-	-	Note:
-	-	-	Material: Gummilippen-Dichtung, weiß Q-LON
-	-	-	Note 1:
-	-	-	Note 2:
-	-	-	Volume [mm ³]: 35089,60
-	-	-	Weight [g]: 35,59
-	-	-	Surface [mm ²]: 111204,36
-	-	-	Scale: 4:1
-	-	-	Creator:
-	-	-	Drawing created date: 14-04-2009
-	-	-	Part/assembly file: R1-92165